



PS1.500 / PS4.110

User manual
Slim amplifiers



PERFORMANCE

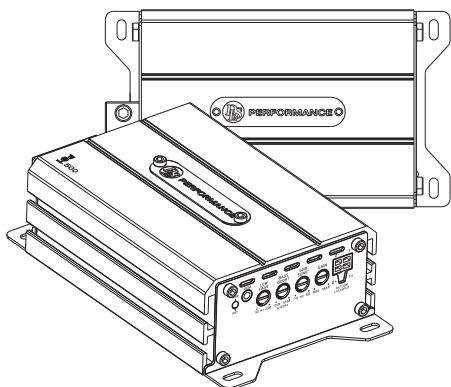

Welcome to DLS!

Thank you for buying a DLS Performance amplifier. For us, it's all about the sound experience. We care deeply about sound and construction quality. In order for your experience to be as optimal as possible, it is important that you fully read this manual, preferably before you start your installation. Keep the manual in a safe and accessible place for future reference.

Your amplifier must be installed correctly in order to work as intended. Make sure you have all necessary tools nearby before starting and that you are completely confident in how to proceed. If you feel the slightest uncertainty; feel free to take the help of an experienced installer or a car audio dealer.

Warranty

This amplifier is covered by warranty, depending on the conditions in the country where it is sold. If the product is returned for service, please include the original dated receipt with the product.

DECLARATION OF CONFORMITY

DLS amplifiers for vehicles are manufactured in accordance with the EU directive EEC 95/54 (72/245/ EEC) and are marked with the approval number. They are also marked in accordance with the WEEE-directive 2012/19/EC. The products are also produced in accordance with the EU RoHS directive 2015/863/EU.

DLS PERFORMANCE

PS1.500 & PS4.110

Content

Welcome	2
Features	3
Pre-installation	3
Amplifier Location	3
Disconnect battery	3
Installation	3
Routing wires	3
Tools and materials	4
Power wiring	4-5
Audio wiring	5
Input level control - GAIN	6
High pass filter - HPF	6
Low pass filter - LPF	6
Subsonic filter	6
Model features	6
PS1.500 speaker wiring	7
PS4.110 speaker wiring	8-9
Testing	10
Troubleshooting	10
Professional tips	11
Noise problems	11
Installation in trunk	11
Crimp connections	11
Speaker polarity check	11
Securing wires	11
Speaker & power wires	11
Specifications	12
Product Markings	13

DLS products are engineered by DLS Sweden,
a part of:

Winn Scandinavia AB

Idrottsvägen 37 - SE-702 32 Örebro - Sweden

Tel: +46 19 20 67 65 - E-mail: info@dls.se

www.dls.se

Designed & Sound tuned in Sweden.



Features

The amplifiers include the following features:

- Class D technique
- High efficiency
- Slim profile design
- RCA line inputs
- High level input with auto start
- Powerful DC cable terminals
- Built-in active crossovers
- Remote sub level control (on PS1.500)

Pre-installation

Amplifier location

Important!

Allow air circulation around the amplifier.

The DLS Performance series of amplifiers have a compact design that allows great flexibility in mounting. You can mount it under a seat or in the trunk.

When you select a location, do remember that the amplifier generates a lot of heat. Choose a location where air can circulate freely around the amplifier. Do not cover the amplifier with carpets or hide behind trim panels. Do not mount the amplifier in an inverted or upside-down position.

Check all locations and placements carefully before making any cuts, drilling any holes or making any connections.

Disconnect battery

Before you start the process of installing an amplifier, disconnect and secure the negative terminal from your battery/power source. This will prevent the risk of damaging yourself or the products.

Place the disconnected terminal in a secure and isolated location away from any possible connection belonging to the battery/power source system.

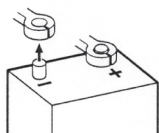

Installation

Routing wires

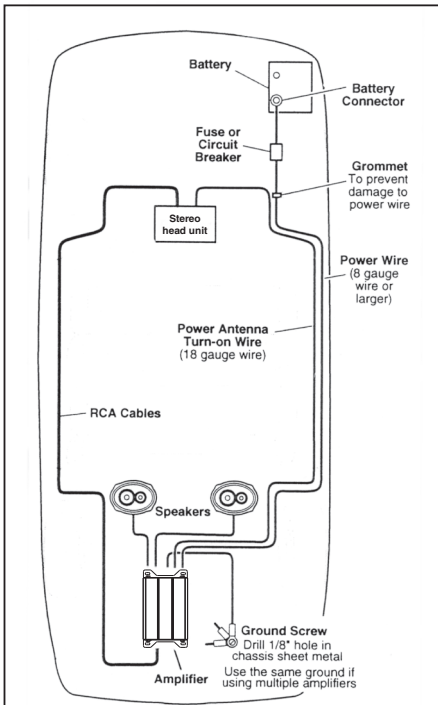

PROFESSIONAL TIP

If amplifier installation kits are available with different sizes of power cable, choose the heaviest power cable to improve sound quality and to allow more amplifiers to be installed now or later.

The oversized power terminals on PS1.500 and PS4.110 accept up to 4 AWG / 20mm² cables. Depending on length we recommend using 4 AWG / 20mm² to PS1.500 and at least 8 AWG/10mm² to PS4.110 for best performance*. Both the positive wire and the ground wire must have the same size. * /OFC copper

NOTE! To avoid cable fire, be sure not to over-size the main fuse value for the power wires.

THE DC-FEED

Maximum main fuse values for different cable sizes:

6 mm ² / 10 AWG: 25 A	10 mm ² / 8 AWG: 40 A
16 mm ² / 6 AWG: 60 A	20 mm ² / 4 AWG: 100 A
35 mm ² / 2 AWG: 150 A	50 mm ² / 1 AWG: 200 A



Tools and materials

TOOLS

- Insex, Flat and Phillips screwdrivers or bits.
- Wire cutter.
- Wire stripper.
- Electric drill with drill bits.
- Crimping tool.
- Digital multimeter or test lamp.
- Wire brush, scraper or a piece of an abrasive sheet to remove paint for a good ground connection.
- Grease to protect the ground connection from oxidation.

MATERIAL

- Speaker wire: minimum 14 AWG = 2,5mm² for subwoofers connected to PS1.500.
- 13-16 AWG = 1,5 - 2,5 mm² for other speakers.
- Sheet metal screws for mounting the amplifier to the amplifier board and the amplifier board to the car plus some extra for fuse holder, amplifier ground etc.
- Electrical insulation tape.
- ½ inch thick plywood or particle board for the amplifier to be mounted upon.

AMPLIFIER INSTALLATION KIT

If available, buy an amplifier installation kit. It contains normally all you need. This is what you have to buy, if you buy the items separately:

- 20-25 feet = 6-7,5 meter power cable, minimum AWG 8 = 10 mm² or heavier.
- 1 pc of fuse holder with fuse to install close to the car battery (see below).
- 20 feet of AWG 15 = 1,5 mm² wire for remote turn on / off cable from radio.
- RCA-cable for input from radio.
 - ~ 20 feet or 5 meter for trunk installations
 - ~ 12 feet or 2-3 meter for under seat installations
- Two ring crimp terminals, one for connection to the battery plus and one for the amplifier ground connection.
- Four to eight splicers to connect speaker cables to high level input cable, if high level input is used.
- Wire ties.
- Insulating grommet or insulating tube.

FUSES

Fuses are installed inside the Performance PS amplifiers.

Recommended fuse rating:

PS1.500:	50A
PS4.110:	40A

NOTE!

Max fuse value is always related to cable size & quality.

Power wiring

POWER TERMINAL (+12V)

Connect the fuse holder as close to the vehicle battery+ as possible, using 4 AWG /20mm² or 8 AWG/10mm² power cable. Use a ring crimp terminal to connect to battery. The 4 AWG/20mm² cable can use a 100 Amp fuse , if the cable is smaller, the fuse value must be lower (see table on previous page). This fuse is to protect from cable fire!

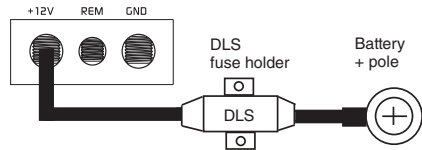

Be sure to use a rubber grommet or a plastic insulating tube where the cable passes the firewall or other places where it can be easily jammed. Use wire ties to secure to existing cables in the engine compartment.

GROUND TERMINAL (GND)

Connect to a good chassis ground. The ground connection should be clean, unpainted metal to provide a good electrical connection. Use a wire brush, a scraper or a piece of an abrasive sheet to clean the metal. Use a lock washer or two to secure contact. Protect with silicon grease or by paint applied afterwards.

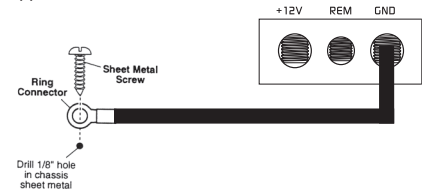

POWER LIGHT / PROTECT LIGHT

The power indicator (blue) is lit when the amplifier is turned on.



The protect indicator (red) is lit when the amplifier shuts down from over-heating, or a short circuit (speaker failure). Turn off your audio system to reset the amplifier if the red protect light is turned on. If the red lamp doesn't turn off, contact your local dealer for advice.



REMOTE TERMINAL (REM)

For RCA cable signal input:

Connect the radio power antenna lead = remote turn on/off from the car stereo to the amplifier remote connection. This turns on the amplifier whenever the car stereo is turned on. You can either use the built in remote cable in the RCA cable itself or use a separate cable.

Sometimes a small disturbance may enter the amplifier coming from the remote voltage, through the built in remote wire and into the RCA cable. Thus we recommend to use a separate remote wire and run the RCA lead separate from remote wire, power cables and speaker cables.

If there is no remote voltage available from the stereo, you must connect to the ignition key through the radio or any accessories fuse. When high level input is used the amplifier starts automatically when your car stereo is switched on.

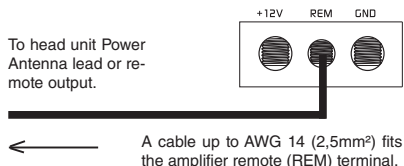

Audio wiring

LOW LEVEL INPUT WIRING

Inputs may be low level from the RCA output of the car stereo or high level from the car stereo speaker output. Low level = RCA is preferred for the best sound quality.

Important!

Use either the low level or high level input, do not use both at the same time.

Use a pair of shielded stereo audio cables with RCA type jack. Most trunk-mounted amplifiers need a 20 feet RCA cable (approximately 5 – 6 meters).

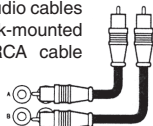

Connect to input socket **CH1 / CH2** on **PS1.500**.

PS4.110 has dual inputs **CH1 / CH2** and **CH3 / CH4** depending on your chosen configuration you can use either two separate RCA cables, or a single RCA cable and set the INPUT MODE switch to 4CH or 2CH.

HIGH LEVEL INPUT WIRING

Most headunits are pre-installed from the car factory and have no RCA output, in this case you can take the signal from the speaker output instead. Use either a separate remote cable or let the high level signal automatically start the amplifier.

Connect left and right speaker wires coming from the car stereo to the high level input as shown. You must connect both plus and minus as the inputs are balanced, connecting plus only gives lower level and bad sound quality. By changing the polarity of plus and minus, you can change the phase.

The High level connector wires match with DIN wiring color codes. The car loom wiring may have different color codes. When High level inputs are used, the turn on signal for the amplifier is taken from the high level input, therefore no separate remote wire is needed.

PS1.500

Connected high level left and right are summed on the inside.

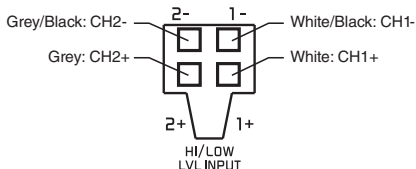

PS4.110

The four channel amplifier is connected likewise, however it has four channels. You can feed two channels from RCA and two channels using high level input from rear speaker cables, or all channels from high level input.

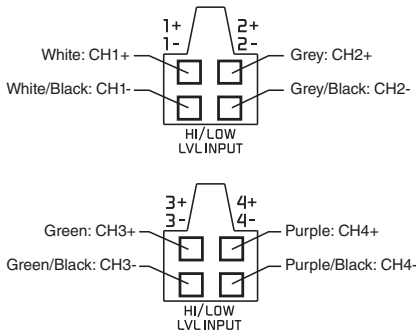



Input level control - GAIN

The GAIN control, MIN – MAX, matches the output of your radio to the input of the amplifier. After installation is complete, make sure the input of the amplifier is turned down all the way to MIN. After turning the head unit ON, you can adjust the GAIN level, A normal setting is from 12 - 14 o'clock.



High Pass Filter - HPF

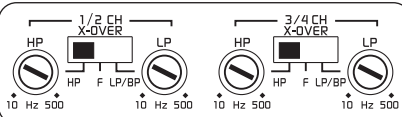

PS4.110

The high pass filter blocks low frequencies from reaching the speakers, mostly used to protect small speakers from deep bass.

Set the 1/2CH X-OVER and the 3/4CH X-OVER switches to **HP** to activate the filter, set the switch in the middle position **F** if you want to run the amplifier in full range mode without limiting the frequency range.

Low Pass Filter - LPF

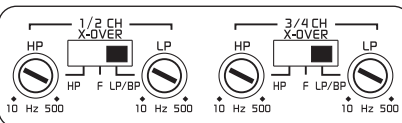

PS4.110

The low pass filter is mostly used for subwoofers. It will allow low frequencies only and blocks higher frequencies. For a subwoofer a typical setting is 60 – 80 Hz. For midbass a typical setting is 200-300Hz.

Set the 1/2CH X-OVER and the 3/4CH X-OVER switches to **LP/BP** to activate the filter, set the switch in the middle position **F** if you want to run the amplifier in full range mode without limiting the frequency range.

BP means Bandpass filter and it activates the HP filter as well. To limit the lowest frequencies from the connected speaker.

Low Pass Filter - LPF

PS1.500

The low pass filter is mostly used for subwoofers. It will allow low frequencies only and blocks higher frequencies. For a subwoofer a typical setting is 60 – 80 Hz.

Bass EQ or Bass boost is used to increase the bass volume at a specific frequency (45Hz). You can adjust the amplification from 0dB (no amplification) to +18dB.

This function is used to compensate for the bass box function and to adjust for your own taste of bass. Set level control at 0 dB if you want it to be inoperative.

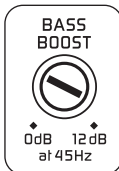

Subsonic filter

PS1.500

The subsonic filter is adjustable between 10Hz–50Hz and reduces the lowest frequencies below 50 Hz. If small woofers are used use a higher frequency setting for the subsonic filter. Choose the frequency that best suits your ears and the installation.

Subsonic filters are recommended with Vented / Ported enclosures to prevent subwoofer damage from exceeding X-Max at frequencies below the box tuning frequency.



Model features

PS1.500 is a Mono amplifier for subwoofers with the following features:

- Low pass filter (adjustable 50-250Hz)
- Subsonic filter (adjustable 10-50Hz)
- Bass EQ (adjustable 0 to +18dB)
- Remote level control

PS4.110 is a 4-channel amplifier which can be used for front and sub, front and rear or 2-way active operation. It has the following features:

- Low pass / Band pass filter (adjustable 10-500Hz)
- High pass filter (adjustable 10-500Hz)
- Filters can be switched off for fullrange operation



PS1.500 speaker wiring

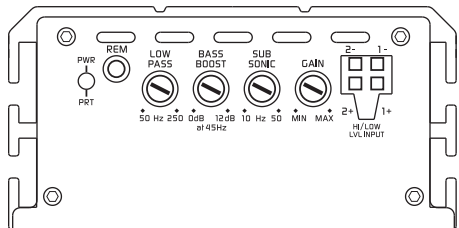
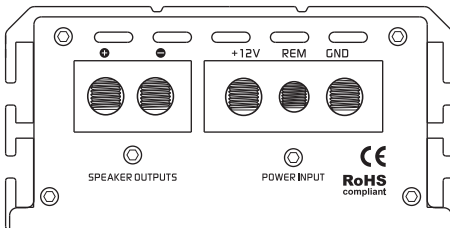

TWO 4 OHM SUBWOOFERS

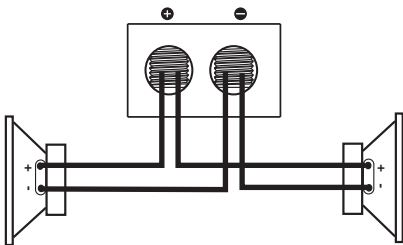

NOTE! Two 4 ohm subwoofers gives a 2 ohm load when connected in this way. The minimum amplifier load is 1 ohm, lower impedances may damage the amplifier!

Filter settings Low Pass filter

The low pass filter is mostly used for subwoofers. It will allow low frequencies only and blocks higher frequencies. A typical setting is 60–80 Hz.

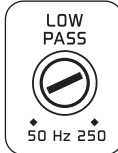

ONE 4 OHM OR 2 OHM SUBWOOFER

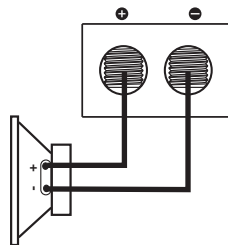

NOTE! Subwoofer impedance can be 4 ohm or 2 ohm. Minimum amplifier load is 1 ohm, lower impedances may damage the amplifier.

Connections in series or parallel

Subwoofers with dual voice coils, or any subwoofer, can be connected in series or in parallel for various impedances but *the resulting impedance must NEVER be lower than 1 ohm.*

Filter settings Low Pass filter

The low pass filter is mostly used for subwoofers. It will allow low frequencies only and blocks higher frequencies. A typical setting is 60–80 Hz.

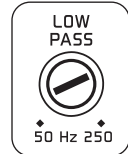

REMOTE SUB LEVEL CONTROL

You can adjust the bass sound level from the front seat of your car if you connect the external sub level control box. The external remote works together with the internal gain control, the setting of the internal gain decides the maximum level also for the external level control. Connect to the **REM** socket on the PS1.500 amplifier.

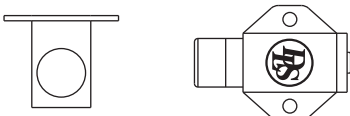



PS4.110 speaker wiring

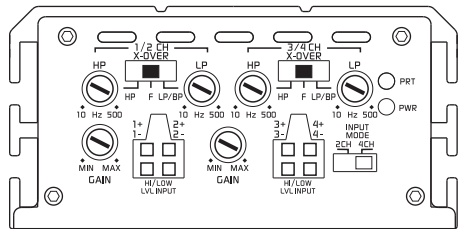
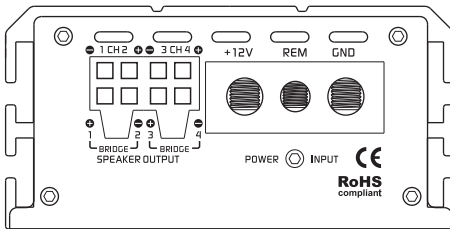

FOUR FULLRANGE SPEAKERS TO CHANNEL 1/2/3/4

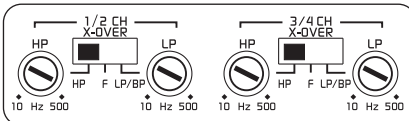
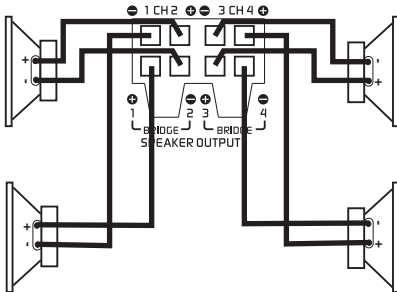

Filter settings front channels (CH 1/2)

The high pass filter blocks very low frequencies from reaching the speakers, mostly used to protect small speakers from deep bass.

Set the 1/2 CH X-OVER switch to **HP** to activate the filter, set the switch in the middle position **F** if you want to run the amplifier in full range mode without limiting the frequency range. Adjust the **HP control** after your own taste, a normal setting is 50-70 Hz.

Filter settings rear channels (CH 3/4)

The high pass filter blocks very low frequencies from reaching the speakers, mostly used to protect small speakers from deep bass.

Set the 3/4 CH X-OVER switch to **HP** to activate the filter, set the switch in the middle position **F** if you want to run the amplifier in full range mode without limiting the frequency range. Adjust the **HP control** after your own taste, a normal setting is 50-70 Hz.

TWO FULLRANGE SPEAKERS & SUBWOOFER BRIDGED (3-CHANNEL MODE)

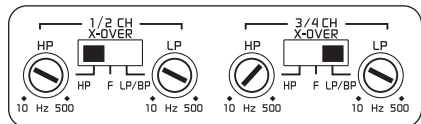
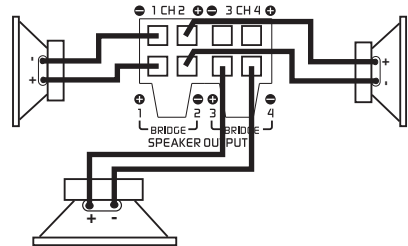

Filter settings front channels (CH 1/2)

The high pass filter blocks very low frequencies from reaching the speakers, mostly used to protect small speakers from deep bass.

Set the 1/2 CH X-OVER switch to **HP** to activate the filter, set the switch in the middle position **F** if you want to run the amplifier in full range mode without limiting the frequency range. Adjust the **HP control** after your own taste, a normal setting is 50-70 Hz.

Filter settings rear channels (CH 3/4)

The low pass filter is mostly used for subwoofers. It allows only low frequencies to reach the speakers and blocks higher frequencies.

Set the 3/4 CH X-OVER switch to **LP/BP** to activate the filter. Adjust with the **LP control** after your own taste, a normal setting is 60-80 Hz. The HPF filter is activated like a band pass function. Turn it down to 10 Hz so that you don't miss any bass. If small woofers are used the HP control can be turned up in frequency.



PS4.110 speaker wiring

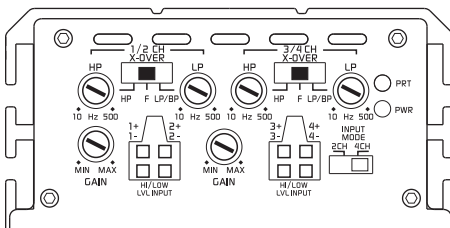
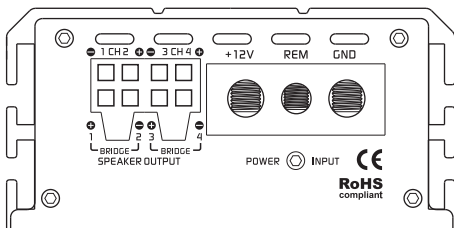

TWO SUBWOOFERS BRIDGED (2-CHANNEL MODE)

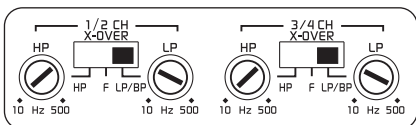
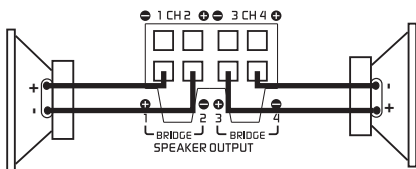

Filter settings front channels (CH 1/2)

The low pass filter is mostly used for subwoofers. It allows only low frequencies to reach the speakers and blocks higher frequencies.

Set the 1/2 CH X-OVER switch to **LP/BP** to activate the filter. Adjust with the **LP control** after your own taste, a normal setting is 60-80 Hz. The HP filter is activated like a band pass function. Turn it down to 10 Hz so that you don't miss any bass. If small woofers are used the HP control can be turned up in frequency.

Filter settings rear channels (CH 3/4)

The low pass filter is mostly used for subwoofers. It allows only low frequencies to reach the speakers and blocks higher frequencies.

Set the 3/4 CH X-OVER switch to **LP/BP** to activate the filter. Adjust with the **LP control** after your own taste, a normal setting is 60-80 Hz. The HP filter is activated like a band pass function. Turn it down to 10 Hz so that you don't miss any bass. If small woofers are used the HP control can be turned up in frequency.

TWO STEREO SPEAKERS BRIDGED (2-CHANNEL MODE)

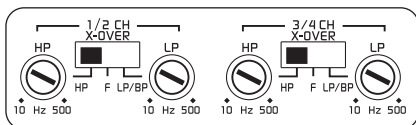
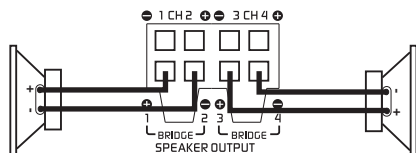

Filter settings front channels (CH 1/2)

The high pass filter blocks very low frequencies from reaching the speakers, mostly used to protect small speakers from deep bass.

When the PS4.110 is used for bridging a stereo speaker pair set, use only the **HP filter**. Set the 1/2 CH X-OVER switch to **HP** to activate the filter. Adjust the **HP control** after your own taste, a normal setting is 50-70 Hz.

Filter settings rear channels (CH 3/4)

The high pass filter blocks very low frequencies from reaching the speakers, mostly used to protect small speakers from deep bass.

When the PS4.110 is used for bridging a stereo speaker pair set, use only the **HP filter**. Set the 3/4 CH X-OVER switch to **HP** to activate the filter. Adjust the **HP control** after your own taste, a normal setting is 50-70 Hz.



Testing

RECONNECT BATTERY

When wiring is complete, re-connect the battery negative terminal.

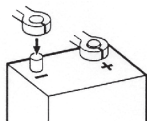

TEST POWER WIRING

1. Turn on the head unit but do not turn up the volume. The amplifier power light should come on. If not, check the remote and +12 volt wires. Also check the ground connection.
2. Turn up the head units volume slightly. All speakers should operate. if not, check wiring connections at amplifier and speakers.

TEST SPEAKER CONNECTIONS

Make sure the speakers are connected right. Use the balance control on the head unit to make sure right channel is on right speaker etc. If speakers don't play at all, one or both speaker wires may be disconnected.

Troubleshooting

If problems occur during the installation, or later, this guide might help you to find out what's wrong.

THE AMPLIFIER IS DEAD

1. Check power lead, ground and remote connections at the amplifier using a multi meter.
2. Check the battery terminal connections.
3. Check the power lead fuse or circuit breaker. If fuse damage continues, inspect the power lead for short circuits.
4. Check the amplifier protection fuses. Are these broken change to new ones with the same value. If short circuiting continues, contact your local DLS dealer. A fault may be in the amplifier.
5. To start the amplifier requires a remote voltage of 9-15 volt. Check the voltage with a multi meter.

AMPLIFIER PROTECTION FUSE BLOWS AT LOW VOLUME

1. One or more speaker cables are shorted. Make an insulation test with a multi meter. The cables must not have a connection to earth.

AMPLIFIER PROTECTION FUSE BLOWS AT LOW VOLUME

The amplifier is overheating due to inadequate ventilation. Check mounting position is clear:

1. Move the amplifier to a location with better ventilation.
2. Install one or two fans to cool down the heat-sink.
3. Overheating can also be caused by impedance load below the level permitted.

NO OUTPUT FROM ONE OR MORE SPEAKERS

1. Check balance control position
2. Check fader control position.
3. Check all speaker cable connections.
4. Check signal lead plugs and cables.
5. Change left and right signal lead plugs in the amplifier to see if the problem moves to a different speaker, the lead has a fault. If the problem remains, the speaker or amplifier is at fault.



Professional tips

Noise problems

WHINING NOISE VARYING WITH ENGINE REVOLUTIONS

Do this:

1. Rewire the power supply (12 V) to source unit direct from battery.
2. Rewire ground wire from source unit to clean position on chassis.
3. Check all power connections to ensure that they are clean and tight.
4. Check quality of system ground connection.
5. Install a power capacitor with connections as close as possible to the alternator. This bypasses the noise at source and eliminates many issues with noise problems. In cars with a jump start connection, this provides a convenient connection point for the capacitor.

CONSTANT WHINING NOISE

Do this:

1. Ensure that all equipment has a common ground point.
2. Check quality of earth strap connection from battery negative terminal to chassis.
3. Disconnect signal cables from amplifier to see if noise disappears. If so the leads are picking up noise. Test this by laying a new cable over the seats and reconnecting to the amplifier. If the noise does not return, reroute original cable away from source of interference. If noise remains regardless of cable position, try to use so called Quasi-balanced signal cables. DLS PRO-cables are Quasi-balanced.

Installation in trunk

When installing the amplifier in the trunk, run the power wires along the same path as the other vehicle wiring. Many cars have insulated channels for wiring. You will have to remove the door sill trim and the carpet.

Crimp connections

Purchase crimp connectors and crimping tool. Connectors are color coded.

1. Strip 1/4 inch (6mm) of insulation from the wire
2. Insert into connector
3. Crimp tightly

Speaker polarity check

All speakers in a car audio system should be connected in phase (the same polarity). All speaker cones must move in the same direction. Out of phase speakers will cause a lack of bass, and a poor stereo soundstage.

Checking polarity:

Hold the - connection of the speaker wire to the - terminal of a 1,5 Volt flashlight battery. Tap the + wire on to the + terminal of the battery, and observe the movement of the cone. The cone should move outwards when the wire touches the battery, and inwards when the battery is removed. If it is the other way around, the speaker has been connected backwards and it must be removed and connected correctly.

If your system also has a subwoofer connected through a passive 6 or 12 dB crossover, try to connect this with various polarity and judge what sounds best. The phase shift in passive crossovers sometimes makes it necessary to change polarity.

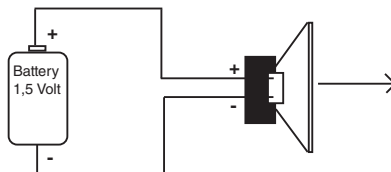

NOTE! Tweeters can not be tested this way, double check the connections instead.

Securing wires

Use wire ties to bundle together when possible. (But never bundle speaker wires or signal cables together with power wires).



Speaker & Power wires

Do not run speaker and power wires next to each other. Power wires can generate a "siren" sound in the speakers. Run speaker and power wires on opposite sides of the car.



Specifications

	PS4.110	PS1.500
Number of channels	4	1
Amplifier class	D	D
Power output RMS in 1 ohm	N/A	1x500 Watt
Power output RMS in 2 ohm	4x110 Watt	1x380 Watt
Power output RMS in 4 ohm	4x70 Watt	1x230 Watt
Power output RMS 4 ohm bridged	2x220 Watt	N/A
Signal to noise ratio, A-weighted	93dB	93dB
THD @ 4 ohm	<0.1%	<0.1%
Efficiency @ 4 ohm	86%	90%
Frequency response	10 Hz – 40 kHz (+/-1dB)	10 Hz – 250 Hz (+/-1dB)
Input impedance, low level	20k ohm	20k ohm
Input sensitivity	0,3V – 7V (+/-5%)	0,3V – 7V (+/-5%)
High level input with auto start	Yes	Yes
High pass filter adjustable	10 Hz – 500 Hz	N/A
Low pass filter adjustable	10 Hz – 500 Hz	50 Hz – 250 Hz
Subsonic filter adjustable	N/A	10 Hz – 50 Hz
Bass EQ @ 45Hz	N/A	0 to +18dB
Power consumption, Idle	0,5 A	0,5 A
Power consumption, Max	40 A	42 A
Recommended Fuse Rating	40 A	50 A
Dimensions HxWxD(mm)	44 x 88 x 161 mm	44 x 88 x 161 mm
Dimensions (inch)	1,72 x 3,46 x 6,34 inches	1,72 x 3,46 x 6,34 inches
Weight	0,6 kg	0,6 kg

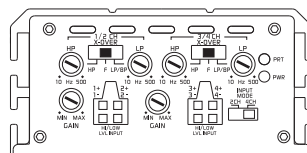
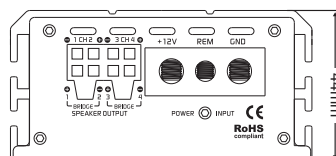
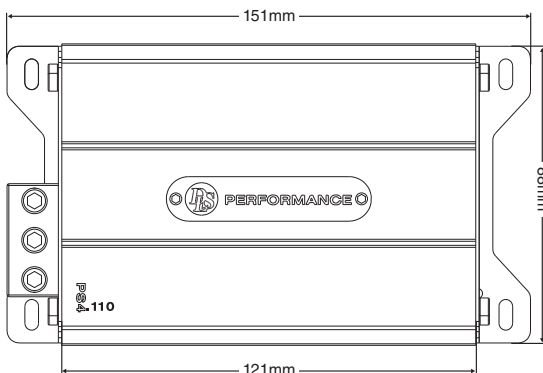

(NOTE! The dimensions are the same for the PS4.110 and PS1.500 amplifiers)



Product markings



The crossed-out wheellie bin symbol means that the product, literature and packaging included must be taken to separate collection at the end of their working life. Do not dispose of these products as unsorted municipal waste: take them for recycling. For info on your nearest recycling point, check with your local waste authority.



This product has been granted with the CE certification mark to show that the product follows the health, safety, and environmental protection standards for products sold within the European Economic Area (EEA).



DLS products complies with the relevant provisions of the RoHS Directive for the European Union. In common with all Electrical and Electronic Equipment (EEE) the product should not be disposed of as household waste. Alternative arrangements may apply in other jurisdictions.



DLS is a global partner of the European Mobile Media Association, an organisation that focus on promoting the custom made mobile media installations to consumers.

We follow a policy of continuous advancement in development. For this reason all or part of specifications & designs may be changed without prior notice. We reserve for possible typos, factual or numeric errors that may have been printed on any products, package designs, user manuals and/or other included accessories.



PERFORMANCE