



Installation instructions for part 99-7519B

Mazda MX-5 Miata 2009-2015 99-7519B

KIT FEATURES

- DIN radio provision with pocket
- ISO DIN radio provision with pocket
- ISO DDIN radio provision
- **Painted to match factory dash**



KIT COMPONENTS

- A) Radio housing • B) Pocket • C) ISO brackets • D) ISO trim plate • E) ISO DDIN brackets
- F) ISO DDIN trim plate • G) (4) Panel clips

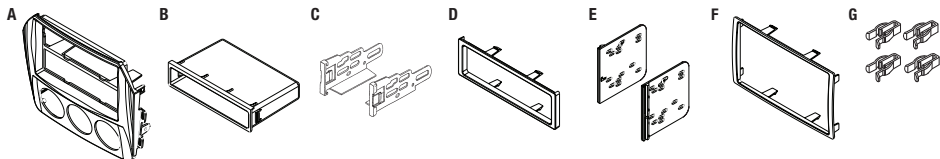

WIRING & ANTENNA CONNECTIONS (sold separately)

Wiring Harness: • 70-7903

Antenna Adapter: • Not required

TOOLS REQUIRED

- Cutting tool • Phillips screwdriver • Socket wrench

Table of Contents

Dash Disassembly	2-3
Kit Preparation	4
Kit Assembly	
– DIN radio provision with pocket	5
– ISO DIN radio provision with pocket	6
– ISO DDIN radio provision	7

CAUTION! Metra recommends disconnecting the negative battery terminal before beginning any installation, unless the vehicle manufacturer recommends against so. Please check with your local Dealership for more information. All accessories, switches, climate controls panels, and especially air bag indicator lights must be connected before reconnecting the battery or cycling the ignition. Also, do not remove the factory radio with the key in the on position, or the vehicle running. It would be best to remove the key from the ignition and then wait a few seconds before removing the factory radio.

REV. 8/18/2015 INST99-7519B

Dash Disassembly

1. Unclip and remove the panel below the steering column. (Figure A)
2. Remove (4) Phillips screws securing the metal brace below the steering column and then remove. (Figure A)
3. Looking at the side of the radio/climate control panel from underneath the steering column opening, remove (1) 10mm bolt from the side of the radio chassis. (Figure B)
4. With the center console lid closed, unclip and remove the cover on the back side of the center console and remove the (2) Phillips screws revealed. (Figure C)
5. Remove the rubber mat inside of the cup holder then remove (1) Phillips screw revealed. (Figure D)
6. Unclip, unplug and remove the entire center console. (Figure E)

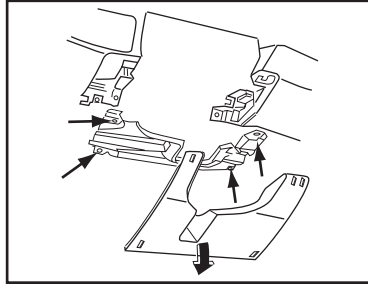

(Figure A)

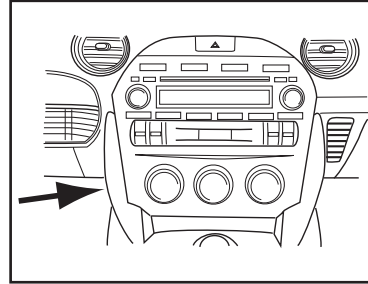

(Figure B)

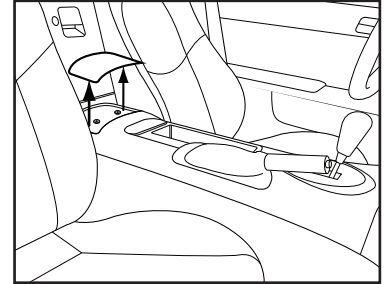

(Figure C)

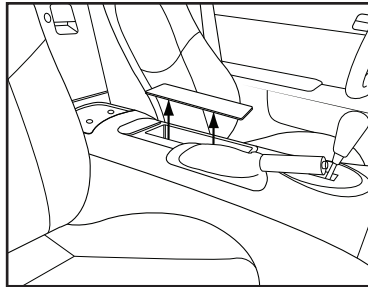

(Figure D)

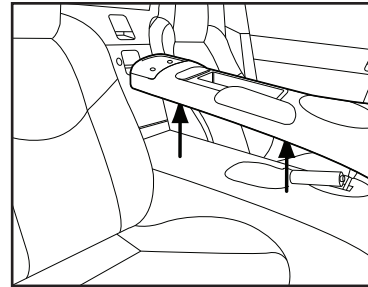

(Figure E)

Continue on next page

Dash Disassembly

7. Remove the (2) Phillips screws securing the side panels from each side of the radio/climate control panel. (Figure F)
8. Carefully remove the side panels from each side of the radio/climate control panel by pulling straight back towards the rear of the car. (Figure G)
9. Remove (1) Phillips screw from each side of the radio/climate control panel. (Figure H)
10. Pull the radio/climate control panel out, then disconnect the plugs and remove. (Figure I)
11. Turn the radio/climate control panel over and remove (4) screws that hold the climate control to the bezel, then remove the climate control. (Figure J)

Continue to kit preparation

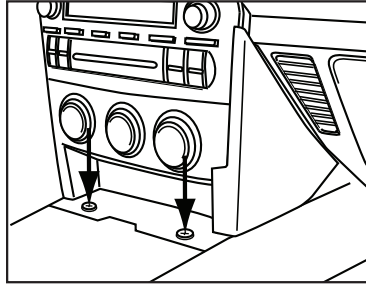

(Figure F)

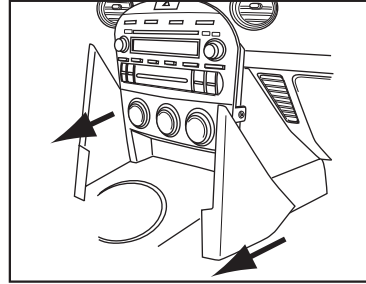

(Figure G)

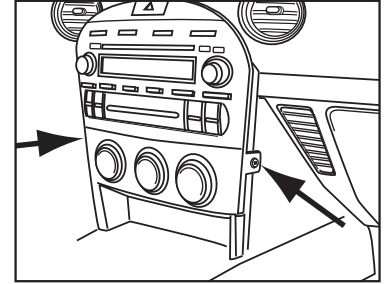

(Figure H)

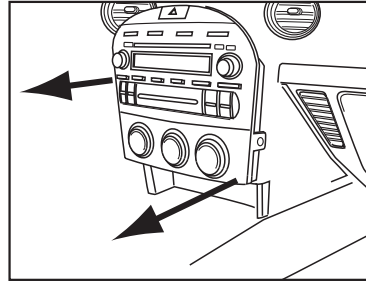

(Figure I)

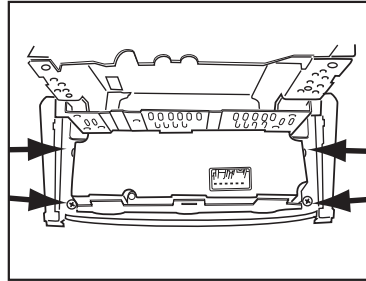

(Figure J)

Kit Preparation

1. Attach (4) Panel Clips to the posts on the back of the Radio Housing. (Figure A)
2. Secure the climate control removed in disassembly to the Radio Housing using the factory screws. (Figure B)

Continue to kit assembly

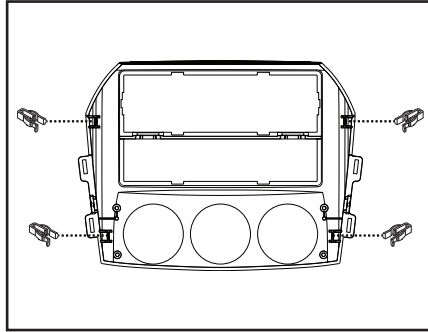

(Figure A)

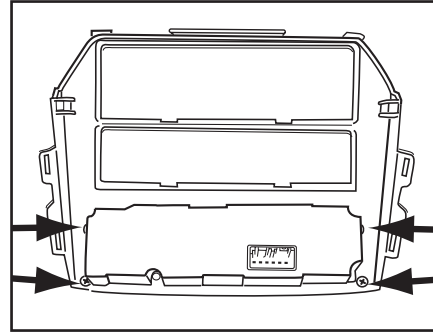

(Figure B)

Kit Assembly

DIN radio provision with pocket

1. Slide the Pocket into the bottom section of the Radio Housing. (Figure A)
2. Remove the metal DIN sleeve from the aftermarket radio.
3. Slide the DIN sleeve into the Radio Housing and secure by bending the metal locking tabs down. (Figure B)
4. Slide the aftermarket radio back into the sleeve until it clicks in. (Figure C)
5. Locate the factory wiring harness in the dash. Metra recommends using the proper mating adapter from Metra or AXXESS. Test the radio for proper operation.
6. Reassemble the dash in reverse order of disassembly.

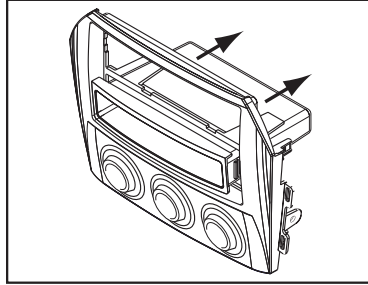

(Figure A)

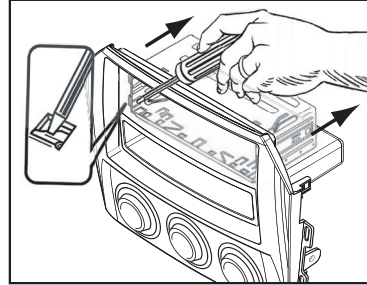

(Figure B)

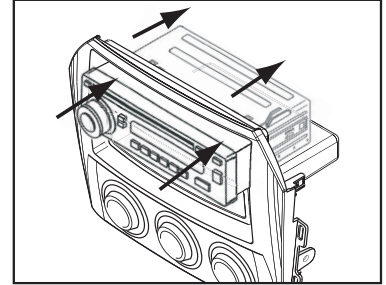

(Figure C)

Kit Assembly

ISO DIN radio provision with pocket

1. Slide the Pocket into the bottom section of the Radio Housing. (Figure A)
2. Remove the metal DIN sleeve and trim ring from the aftermarket radio.
3. Mount the ISO Brackets to the radio using the screws supplied with the radio. (Figure B)
4. Slide the completed assembly into the Radio Housing until it clicks in. (Figure C)
5. Snap the ISO Trim Plate onto the front of the Radio Housing. (Figure C)
6. Locate the factory wiring harness in the dash. Metra recommends using the proper mating adapter from Metra or AXCESS. Test the unit for proper operation.
7. Reassemble the dash in reverse order of disassembly.

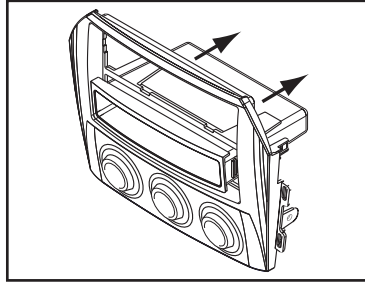

(Figure A)

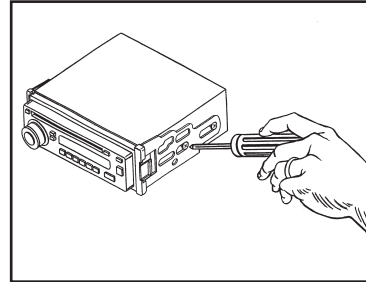

(Figure B)

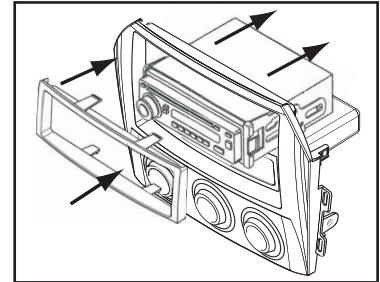

(Figure C)

Kit Assembly

ISO DDIN radio provision

1. Cut the rib in the middle of the Radio Housing to make room for the ISO DDIN Brackets. (Figure A)
2. Attach the ISO DDIN Brackets onto the Radio Housing. (Figure B)
3. Slide the radio between the ISO DDIN Brackets and secure it using the screws supplied with the radio. (Figure C)
4. Snap the ISO DDIN Trim Plate into the Radio Housing. (Figure C)
5. Locate the factory wiring harness in the dash. Metra recommends using the proper mating adapter from Metra or AXCESS. Test the radio for proper operation.
6. Reassemble the dash in reverse order of disassembly.

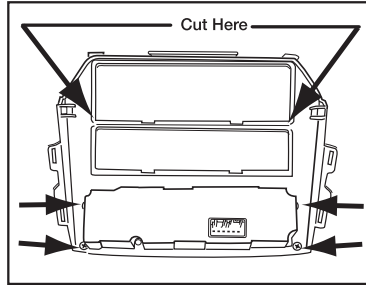
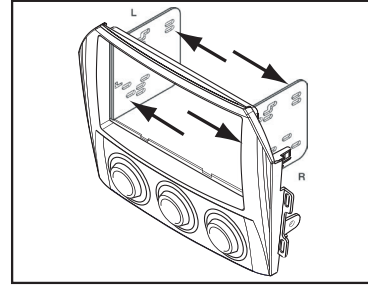
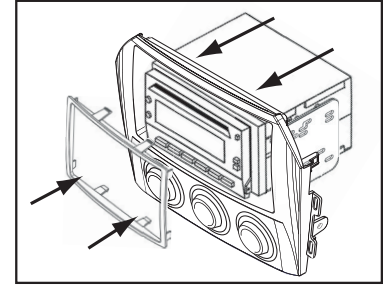
*(Figure A)**(Figure B)**(Figure C)*



Installation instructions for part 99-7519B



IMPORTANT

If you are having difficulties with the installation of this product, please call our Tech Support line at **1-800-253-TECH**. Before doing so, look over the instructions a second time, and make sure the installation was performed exactly as the instructions are stated. Please have the vehicle apart and ready to perform troubleshooting steps before calling.



KNOWLEDGE IS POWER

Enhance your installation and fabrication skills by enrolling in the most recognized and respected mobile electronics school in our industry. Log onto www.installerinstitute.com or call 800-354-6782 for more information and take steps toward a better tomorrow.



**Metra recommends MECP
certified technicians**

REV. 8/18/2015 INST99-7519B



Instrucciones de instalación para la pieza 99-7519B

Mazda MX-5 Miata 2009-2015 99-7519B

CARACTERÍSTICAS DEL KIT

- Provisión de radio DIN con cavidad
- Provisión de radio ISO DIN con cavidad
- Provisión de radio ISO DDIN
- **Pintado para igualar el tablero de fábrica**



COMPONENTES DEL KIT

- A) Carcasa del radio • B) Cavidad • C) Soportes ISO • D) Placa de moldura ISO • E) Soportes ISO DDIN
- F) Placa de moldura ISO DDIN • G) (4) Ganchos para panel

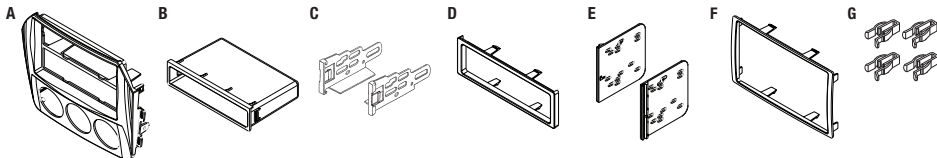

CABLEADO Y CONEXIONES DE ANTENA (se venden por separado)

Arnés de cableado: • 70-7903

Adaptador de antena: • No se requiere

HERRAMIENTAS REQUERIDAS

- Herramienta de corte • Destornillador Phillips • llave de tubo

Índice

Desmontaje Dash.....	2-3
Preparación del kit	4
Ensamble del kit	
– Provisión de radio DIN con cavidad	5
– Provisión de radio ISO DIN con cavidad	6
– Provisión de radio ISO DDIN	7

¡PRECAUCIÓN! Meta recomienda desconectar la terminal negativa de la batería antes de iniciar cualquier instalación, a menos que el fabricante del vehículo recomiende lo contrario. Verifique con su concesionario local si existe más información. Todos los accesorios, interruptores, paneles de controles de clima y especialmente las luces del indicador de las bolsas de aire deben estar conectados antes de reconectar la batería o ciclar la ignición. Además, no quite el radio de fábrica con la llave en la posición de encendido ni con el vehículo funcionando. Sería mejor retirar la llave de la ignición y esperar unos cuantos segundos antes de quitar el radio de fábrica.

Desmontaje Dash

1. Desenganche y quite el panel debajo de la columna de dirección. (Figura A)
2. Quite los (4) tornillos Phillips que sujetan el soporte de metal debajo de la columna de dirección y luego quítelo. (Figura A)
3. Viendo el panel de control de radio/clima por el costado desde debajo de apertura de la columna de dirección, quite (1) perno de 10 mm del costado del chasis del radio. (Figura B)
4. Con la tapa de la consola central cerrada, desenganche y quite la cubierta de la parte trasera de la consola central y quite los (2) tornillos Phillips que quedan expuestos. (Figura C)
5. Quite el tapete de caucho del interior del portavasos y quite (1) tornillo Phillips que queda expuesto. (Figura D)
6. Desenganche, desconecte y quite toda la consola central. (Figura E)

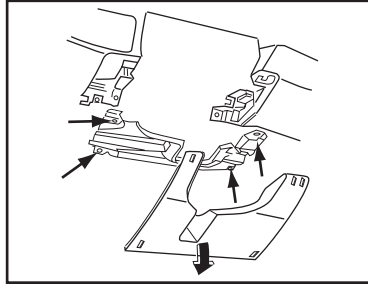

(Figura A)

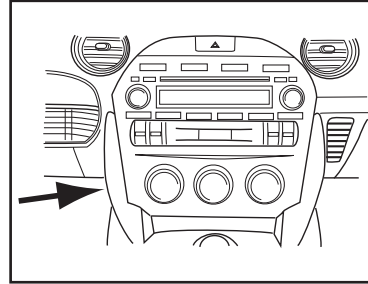

(Figura B)

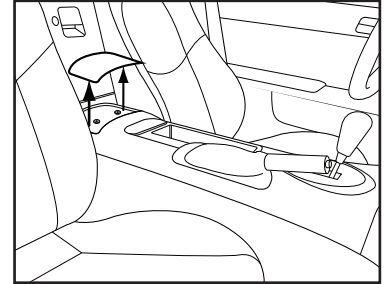

(Figura C)

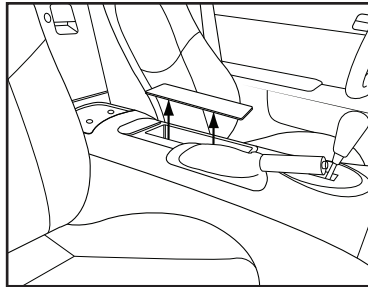

(Figura D)

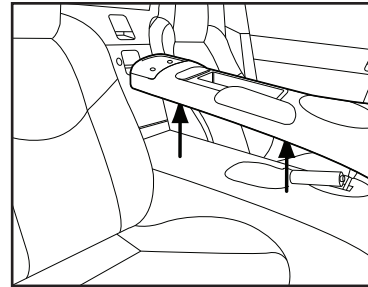

(Figura E)

Continúa en la siguiente página

Desmontaje Dash

7. Quite los (2) tornillos Phillips que sujetan los paneles laterales a cada lado del panel de control del radio/clima. (Figura F)
 8. Con mucho cuidado, quite los paneles laterales de cada lado del panel de control de radio/clima jalando en línea recta hacia atrás hacia la parte trasera del vehículo. (Figura G)
 9. Quite (1) tornillo Phillips de cada lado del panel de control del radio/clima. (Figura H)
 10. Jale el panel de control de radio/clima para sacarlo, luego desconecte los tapones y retire. (Figura I)
 11. Voltee el panel de control de radio/clima y quite los (4) tornillos que sujetan el control de clima al bisel, luego quite el control de clima. (Figura J)
- Continúe con la preparación del kit*

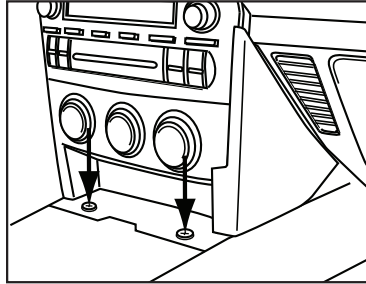

(Figura F)

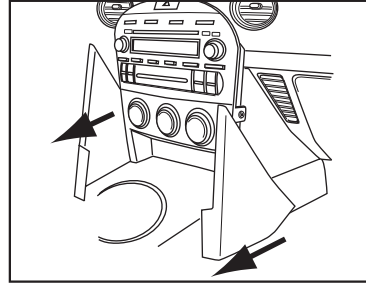

(Figura G)

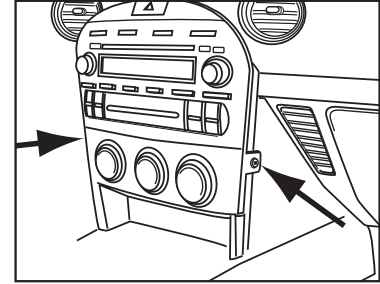

(Figura H)

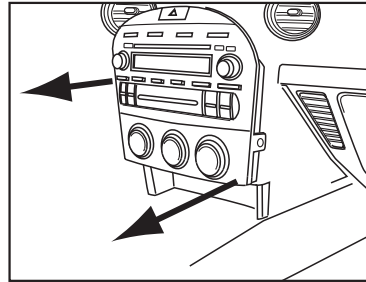

(Figura I)

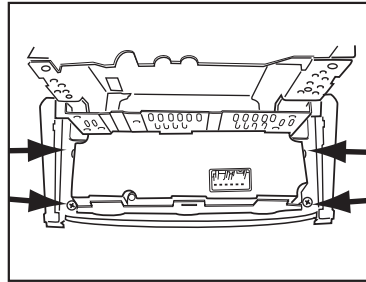

(Figura J)

Preparación del kit

1. Coloque los (4) ganchos del panel en la parte posterior de la carcasa del radio. (Figura A)
2. Atornille el control de clima que quitó durante el desensamble a la carcasa del radio usando la tornillería de fábrica. (Figura B)

Continúe con el ensamble del kit

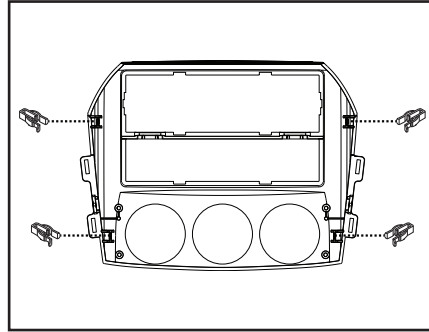

(Figura A)

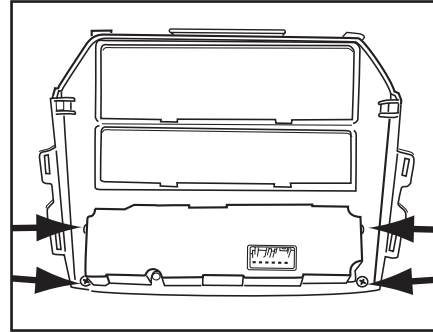

(Figura B)

Ensamble del kit

Provisión de radio DIN con cavidad

1. Deslice el bolsillo en la parte inferior de la carcasa de radio. (Figura A)
2. Quite la manga de metal DIN y el anillo de moldura del radio de mercado secundario.
3. Deslice la manga DIN en la carcasa del radio y sujétela doblando hacia abajo las pestañas de metal. (Figura B)
4. Deslice del radio de mercado secundario de nuevo en la manga hasta que haga clic. (Figura C)
5. Localice el arnés de cableado de fábrica en el tablero. Metra recomienda que use adaptadores adecuados de acoplamiento de Metra y/o de AXXESS. Pruebe el radio para verificar que funcione correctamente.
6. Vuelva a armar el tablero al revés de como lo desarmó.

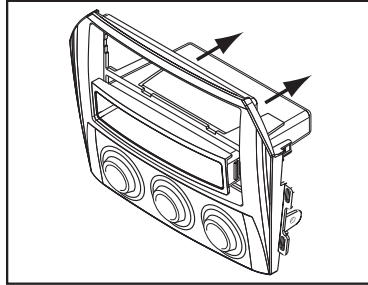

(Figura A)

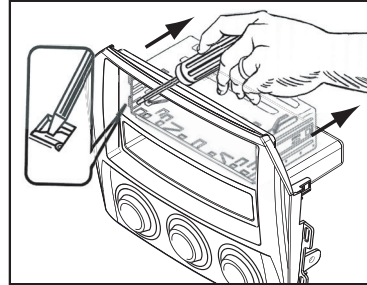

(Figura B)

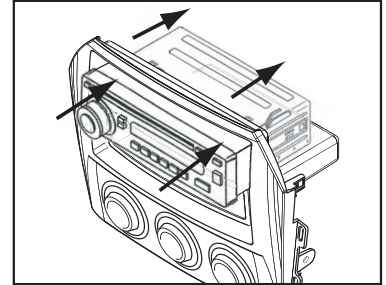

(Figura C)

Ensamble del kit

Provisión de radio ISO DIN con cavidad

1. Deslice el bolsillo en la parte inferior de la carcasa de radio. (Figura A)
2. Quite la manga de metal DIN y el anillo de moldura del radio de mercado secundario.
3. Monte los soportes ISO en el radio con los tornillos que vienen con el radio. (Figura B)
4. Deslice el ensamble terminado en la carcasa del radio hasta que haga clic. (Figura C)
5. Coloque a presión la placa de la moldura al frente de la carcasa del radio. (Figura C)
6. Localice el arnés de cableado en el tablero. Metra recomienda que use adaptadores adecuados de acoplamiento de Metra y/o de AXXESS. Pruebe el radio para verificar que funcione correctamente.\
7. Vuelva a armar el tablero al revés de como lo desarmó.

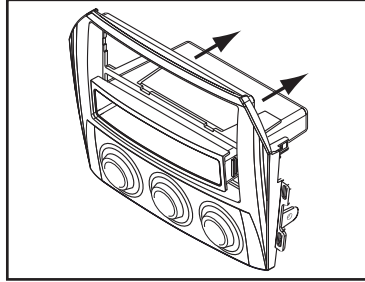

(Figura A)

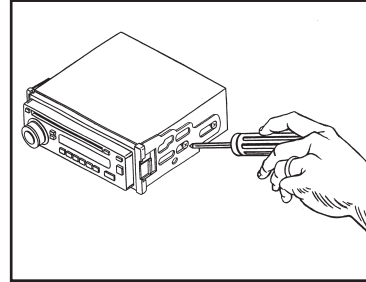

(Figura B)

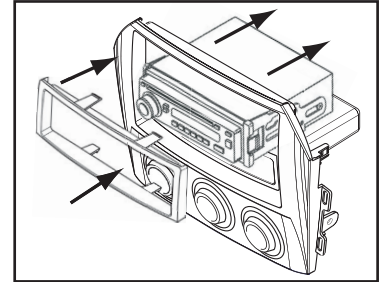

(Figura C)

Ensamble del kit

Provisión de radio ISO DDIN

1. Corte la costilla a la mitad de la carcasa del radio para hacer espacio para los soportes ISO DDIN. (Figura A)
2. Una los soportes ISO DDIN a la carcasa del radio. (Figura B)
3. Deslice el radio entre los soportes ISO DDIN y sujételo con los tornillos suministrados con el radio. (Figura C)
4. Coloque a presión la placa de moldura ISO DDIN en la carcasa del radio. (Figura C)
5. Localice el arnés de cableado de fábrica en el tablero. Metra recomienda que use adaptadores adecuados de acoplamiento de Metra y/o de AXCESS. Vuelva a conectar la terminal negativa de la batería y pruebe el radio para verificar que funcione correctamente.
6. Vuelva a armar el tablero al revés de como lo desarmó.

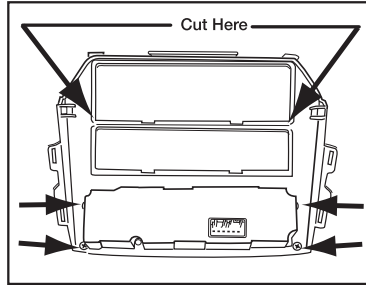

(Figura A)

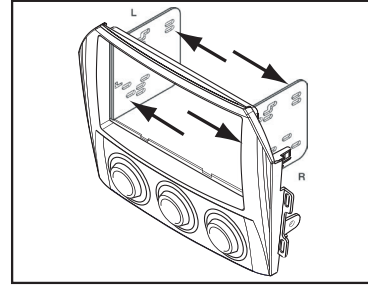

(Figura B)

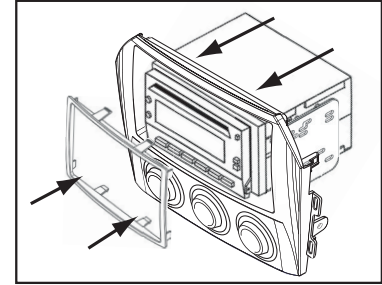

(Figura C)



Instrucciones de instalación para la pieza 99-7519B



REV. 8/18/2015 INST99-7519B

IMPORTANTE

Si tiene dificultades con la instalación de este producto, llame a nuestra línea de soporte técnico al **1-800-253-TECH**. Antes de hacerlo, revise las instrucciones por segunda vez y asegúrese de que la instalación se haya realizado exactamente como se indica en las instrucciones. Por favor tenga el vehículo desarmado y listo para ejecutar los pasos de resolución de problemas antes de llamar.



EL CONOCIMIENTO ES PODER
Mejore sus habilidades de instalación y fabricación inscribiéndose en la escuela de dispositivos electrónicos móviles más reconocida y respetada de nuestra industria. Regístrese en www.installerinstitute.com o llame al 800-354-6782 para obtener más información y avance hacia un futuro mejor.



Metra recomienda técnicos con certificación del Programa de Certificación en Electrónica Móvil (Mobile Electronics Certification Program, MECP).